



# Bridge Design Details 2.1 October 2022

## Bridge Layout

This section describes vertical and horizontal curve information used to establish the control points and primary geometric characteristics of a structure.



# Bridge Design Details 2.2 October 2019

## Vertical Curves

A vertical curve is used to change the profile of a highway to provide a smooth transition between two sloped grades. The design of a vertical curve is dependent on the intended design speed for the roadway, required drainage, slope, friction, sight distance, and acceptable rate of change.

It is recommended that the vertical curves extend beyond the bridge length, where possible, to minimize the design, drainage issues, and construction complexity of the bridge structure.

There are two types of vertical curves, sag curves and crest curves.

Vertical curve data is shown with a PROFILE GRADE detail on the GENERAL PLAN sheet. Vertical curve data includes:

- Begin Vertical Curve (BVC) station
- End Vertical Curve (EVC) station
- Point of Reversing Vertical Curve (PRVC) station
- Profile Grade approaching the vertical curve (G1%)
- Profile Grade departing the vertical curve (G2%)
- Length of curve (L) feet
- Rate of Change ( $R/c$  %) per station



# Bridge Design Details 2.3 January 2023

## Rate of Change of Vertical Curves

EXAMPLE:

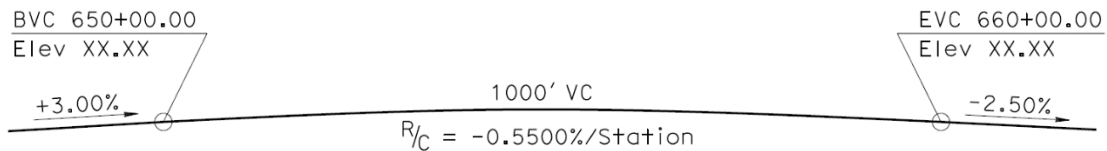

### PROFILE GRADE NO SCALE

$$R/C = \frac{-2.50 - (+3.00)}{10} = \frac{-5.50}{10} = -0.5500\%/Station$$

**Figure 2.3.1 Vertical Curve Profile Grade**

Normally the Rate of Change is given on the PROFILE GRADE and shown on the GENERAL PLAN sheet above the ELEVATION view, where:

$R/C$  = Rate of Change of Grade per Station (% Station)  
(Carry this value to four significant figures to maintain accuracy)

The Rate of Change Formula is:

$$R/C = \frac{\text{Grade at EVC} - \text{Grade at BVC}}{\text{Length of vertical curve}} = \frac{G_2 - G_1}{L}$$

$G_1$  = Grade at first point on curve (%)

$G_2$  = Grade at last point on curve (%)

+G = ascending grade

-G = descending grade

L = Length of vertical curve in stations

# Bridge Design Details 2A October 2019

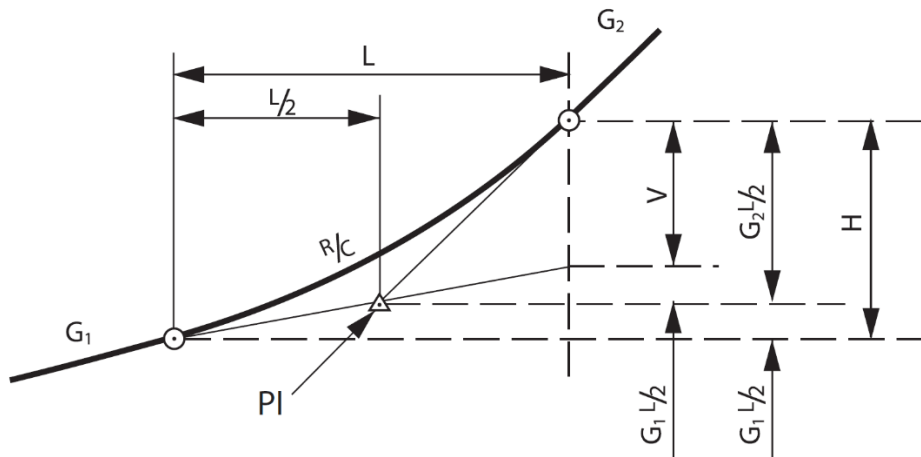

**Figure 2A.A.1 Vertical Curve Formula**

Rate of Change per Station Method Equations:

$$(1) R/c = \frac{G_2 - G_1}{L}$$

$$(2) V = \frac{L \times (G_2 - G_1)}{2}$$

$$(3) H = \frac{L \times (G_2 + G_1)}{2}$$

From these equations, or a combination of these, any point on a vertical curve can be determined.

$V$  = Tangent offset from the first point to the second (feet)

$H$  = Difference in elevation from BVC to EVC (feet)

$PI$  = Projected intersection of the approaching and departing grades

+( $V$  or  $H$ ) measured upward

-( $V$  or  $H$ ) measured downward



# Bridge Design Details 2B October 2019

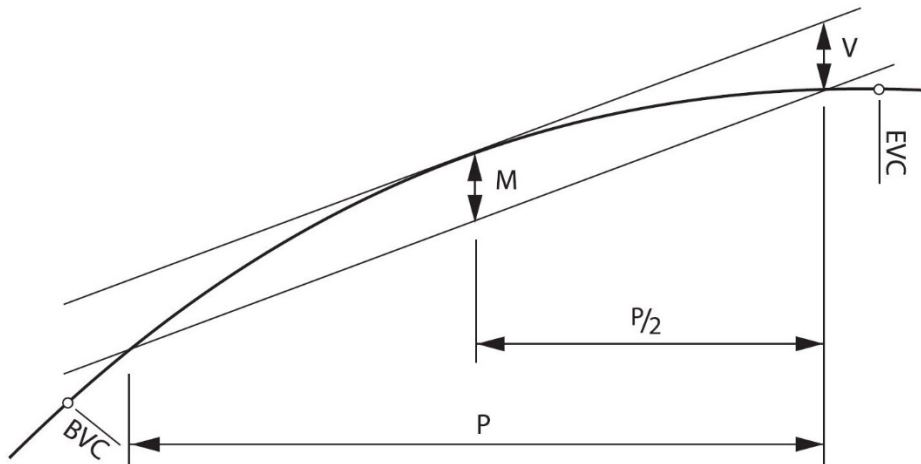

**Figure 2A.B.1 Middle Ordinate Formula**

Combining equations (1) and (2) given in *Bridge Design Details: 2A*, the Middle Ordinate is derived and equation (4) is as follows:

$$(4) V = \frac{R/C \times L^2}{2}$$

For Length =  $P/2$ , then:  $V = \frac{R/C \times (P/2)^2}{2}$

Using the figure and equation above, set M equal to V to get the following:

$$V = \frac{R/C \times (P/2)^2}{2} = M$$

Then simplify to get:  $M = \frac{R/C \times P^2}{8}$

(P) measured horizontally

(M) measured vertically



# Bridge Design Details 2C October 2019

## High Point and Low Point Formula

$$l = \frac{G_1}{R/C}$$

$l$  - Length at high point or low point.

The elevation at any point along a curve is given by the following equation:

$$\emptyset = G_1 + R/C (l)$$

$$l = \frac{G_1}{R/C}$$

**Examples:**

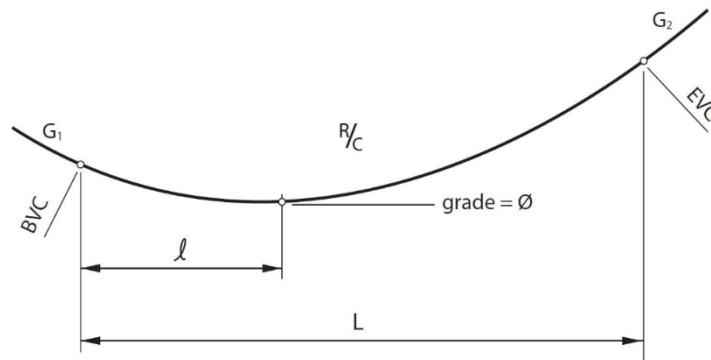

**Figure 2A.C.1 Low Point (Sag Curve)**

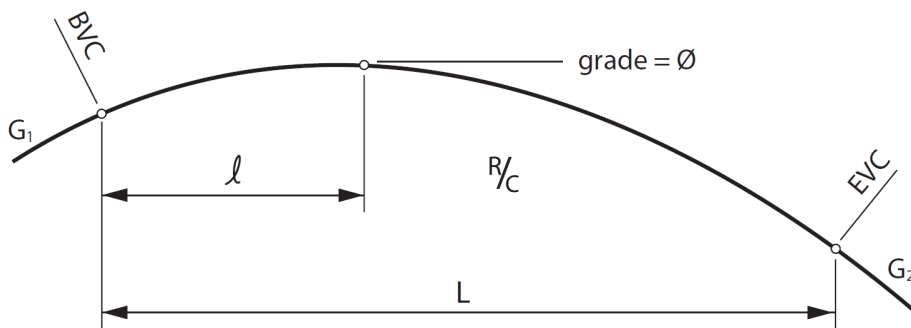

**Figure 2A.C.2 High Point (Crest Curve)**



# Bridge Design Details 2D January 2023

To find the elevation at any given station on a vertical curve, use data given on the PROFILE GRADE and the following equation:

$$(5) (\text{Elev\_PG})_D = (\text{Elev\_BC}) + (D \times G_1) + \frac{D^2 \times R/C}{2}$$

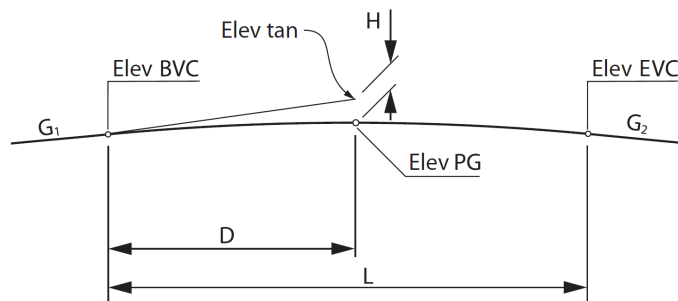

**Figure 2A.D.1 Vertical Curve Definition**

Where:

D = Distance from BVC to a point in stations

$$(6) (\text{Elev\_tan}) = (\text{Elev\_BVC}) + (D \times G_1)$$

$$H = \text{Rise from Profile Grade to (Elev\_tan): } H = \frac{D^2 \times R/C}{2}$$

**Example:**

EXAMPLE:

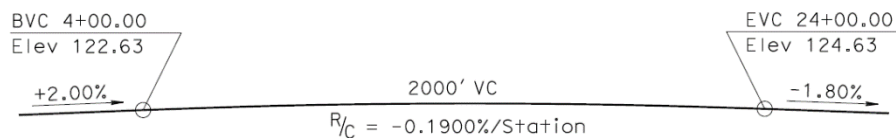

**PROFILE GRADE**  
NO SCALE

Find: Elevation at Station 12+60.00

$$\begin{aligned} \text{Thus: } \text{Elev PG}(12+60.00) &= 122.63 + (8.60)(2.00) + \frac{(8.60)^2(-0.19)}{2} \\ &= 122.63 + 17.20 - 7.03 \\ &= 132.80 \end{aligned}$$

**Figure 2A.D.2 Vertical Curve Example Calculations**



**Example:**

The "Brownell" method for calculating elevations at given stations along a vertical curve.

Given:

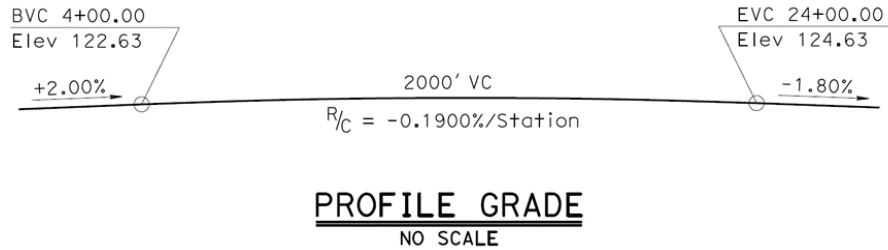

**Figure 2A.D.3 Vertical Curve "Brownell" Example Calculations**

Find elevations at: Abutment 1 at 11+50.00

Bent 2 at 12+60.00

Abutment 3 at 13+70.00

Station	R/c (% / Station)	G (Grade at Station)
BVC 4+00.00	-0.1900	+2.00
11+50.00 Abut 1	-0.1900	+0.5750
12+60.00 Bent 2	-0.1900	+0.3660
13+70.00 Abut 3	-0.1900	+0.1570
EVC 24+00.00	-0.1900	-1.80

Distance	L (Length - Stations)	R/c × L (Change in Grade)	L × Avg G (Change in Elevation)
BVC 4+00.00 to Abut 1	7.50	-1.4250	+9.6562
Abutment 1 to Bent 2	1.10	-0.2090	+0.5175
Bent 2 to Abut 3	1.10	-0.2090	+0.2876
Abutment 3 to EVC 24+00.00	10.30	-1.9750	-8.4614

Station	Elevation
4+00.00 BVC	122.63
<b>11+50.00 Abut 1</b>	<b>132.28</b>
<b>12+60.00 Bent 2</b>	<b>132.80</b>
<b>13+70.00 Abut 3</b>	<b>133.09</b>
24+00.00 EVC (Calculated)	124.63
24+00.00 EVC (Given)	124.63





# Bridge Design Details 2.4 October 2019

## Horizontal Curves

Roadway Designers use simple arcs for the design of roadway horizontal curves. The horizontal curve length is the distance between two tangent lengths that provides a safe sight distance for traffic moving at a specified design speed.

It is recommended that horizontal curves extend beyond the bridge length, if possible, to minimize the design and construction complexity of the bridge structure. Horizontal curve data includes:

- Beginning of Curve (BC) station
- End of Curve (EC) station
- Point on Curve (POC) station
- Point of Intersection (PI) station
- Bearings of Tangents
- Radius (R) feet
- Central Angle ( $\Delta$ ) degrees
- Tangent Distance (T) feet
- Length of Curve (L) feet
- Point of Compound Curve (PCC) station
- Point of Reverse Curve (PRC) station



# Bridge Design Details 2E October 2019

## Horizontal Curve Equations

BC = Beginning of Curve

EC = End of Curve

d = Deflection Angle for point on curve

$\Delta$  = Delta or Central Angle

L = Length along Curve (BC to POC)

L = Length of Curve =  $\frac{2\pi R}{360^\circ} \Delta$

LC = Long Chord =  $2R \left(1 - \sin \frac{\Delta}{2}\right)$

M = Middle Ordinate =  $R \left(1 - \cos \frac{\Delta}{2}\right)$

PC = Point of Curvature

PI = Point of Intersection

POC = Point on Curve

PT = Point of Tangency

R = Radius

T = Tangent Distance =  $R \tan \frac{\Delta}{2}$

Ex = External =  $\left( \frac{R}{\cos \frac{\Delta}{2}} - R \right)$

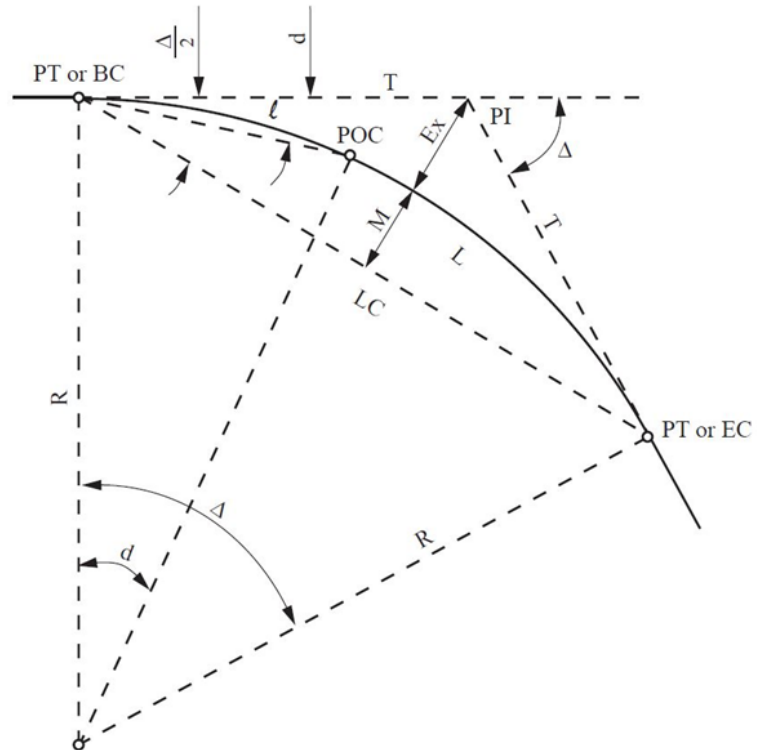

Figure 2A.E.1 Horizontal Curve Functions

All Curve Data may be obtained with two of the following curve parameters:

- Delta ( $\Delta$ )
- Radius
- Tangent
- Length
- External



**Example:**

Given Length and Radius, solve for Delta  $\Delta$ .

$$T = R \tan \frac{\Delta}{2} \quad L = \frac{2\pi R}{360^\circ} \Delta$$

$$\tan \frac{\Delta}{2} = \frac{T}{R} \Rightarrow 2 \tan^{-1} \left( \frac{T}{R} \right), \Delta \text{ in degrees}$$

$$\Delta \text{ in degrees} = \frac{L \times 3,437.7467}{R}$$

**Example:**

Given Radius and Delta  $\Delta$ , solve for L.

$$L = \frac{2\pi R \Delta}{360^\circ} \text{ or } L = R \text{ func } \Delta \Rightarrow \frac{L}{2\pi R} = \frac{\Delta}{360^\circ} \Rightarrow L = \frac{2\pi R}{360^\circ} \Delta \quad \text{where } \Delta \text{ is in degrees}$$

$$d = \frac{\Delta d}{2} \text{ where } \frac{\Delta d}{360^\circ} = \frac{\ell}{2\pi R} \Rightarrow d = \frac{180\ell}{2\pi R} \text{ (in degrees)}$$

$$Ex = \frac{R}{\cos \frac{\Delta}{2}} - R \Rightarrow R \left( \frac{1}{\cos \frac{\Delta}{2}} - 1 \right)$$

$$R - R \cos \frac{\Delta}{2} \Rightarrow R \left( 1 - \cos \frac{\Delta}{2} \right)$$



# Bridge Design Details 2F October 2019

## Tangent Offset for Circular Curves

Radius	50'	100'	150'	200'	250'	300'	400'	500'	600'	700'	800'	900'	1,000'
20,000'	0.06	0.25	0.56	1.00	1.56	2.25	4.00	6.25	9.00	12.25	16.01	20.26	25.02
15,000'	0.08	0.33	0.75	1.33	2.08	3.00	5.33	8.34	12.01	16.34	21.35	27.02	33.37
10,000'	0.13	0.50	1.13	2.00	3.13	4.50	8.00	12.51	18.02	24.53	32.05	40.58	50.13
9,000'	0.14	0.56	1.25	2.22	3.47	5.00	8.89	13.90	20.02	27.26	35.62	45.11	55.73
8,000'	0.16	0.63	1.41	2.50	3.91	5.63	10.01	15.64	22.53	30.68	40.10	50.79	62.75
7,000'	0.18	0.71	1.61	2.86	4.47	6.43	11.44	17.88	25.76	35.09	45.87	58.10	71.80
6,000'	0.21	0.83	1.88	3.33	5.21	7.51	13.35	20.87	30.08	40.97	53.57	67.88	83.92
5,000'	0.25	1.00	2.25	4.00	6.25	9.01	16.03	25.06	36.13	49.24	64.24	81.67	101.02
4,500'	0.28	1.11	2.50	4.45	6.95	10.01	17.81	27.86	40.18	54.78	71.68	90.92	112.52
4,000'	0.31	1.25	2.81	5.00	7.82	11.27	20.05	31.37	45.26	61.73	80.82	102.57	127.02
3,500'	0.36	1.43	3.22	5.72	8.94	12.88	22.93	35.90	51.18	70.71	92.66	117.69	145.90
3,000'	0.42	1.67	3.75	6.67	10.44	15.04	26.79	41.96	60.61	82.81	108.53	138.18	171.57
2,500'	0.50	2.00	4.50	8.01	12.53	18.07	32.20	50.51	73.07	100.00	131.46	167.62	208.71
2,000'	0.63	2.50	5.63	10.03	15.69	22.63	40.41	63.51	92.12	126.50	166.97	213.94	267.95
1,800'	0.70	2.78	6.26	11.15	17.45	25.18	45.01	70.84	102.94	141.69	187.55	241.15	303.34
1,700'	0.74	2.94	6.63	11.81	18.48	26.68	47.73	75.19	109.40	150.81	200.00	257.78	325.23
1,600'	0.78	3.12	7.05	12.55	19.65	28.38	50.81	80.13	116.76	161.25	214.36	277.12	351.00
1,500'	0.83	3.34	7.52	13.39	20.98	30.31	54.32	85.79	125.23	173.35	231.14	300.00	
1,400'	0.89	3.58	8.06	14.36	22.50	32.52	58.36	92.33	135.09	187.56	251.09	327.61	
1,300'	0.96	3.85	8.58	15.48	24.27	35.09	63.07	100.00	146.74	204.56	275.31		
1,250'	1.00	4.01	9.03	16.10	25.26	36.53	65.73	104.36	153.41	214.38	289.53		
1,200'	1.04	4.17	9.41	16.78	26.33	38.11	68.63	109.13	160.77	225.32	305.57		
1,100'	1.14	4.56	10.28	18.34	28.79	41.70	75.31	120.20	178.05	251.47			
1,000'	1.25	5.01	11.31	20.20	31.75	46.06	83.49	133.96	200.00	285.86			

**Table 2A.F.1 Distance from Beginning or End of Curve Along Tangents**



Radius	50'	100'	150'	200'	250'	300'	400'
900'	1.39	5.57	12.59	22.50	35.42	51.47	93.77
800'	1.56	6.28	14.19	25.40	40.07	58.38	107.18
750'	1.67	6.70	15.15	27.16	42.89	62.61	
700'	1.79	7.18	16.26	29.18	46.17	67.54	
650'	1.93	7.74	17.54	31.53	50.00	73.37	
600'	2.09	8.39	19.05	34.32	54.56	80.39	
550'	2.28	9.17	20.85	37.65	60.10		
500'	2.51	10.10	23.03	41.74	66.99		
450'	2.79	11.25	25.74	46.89			
400'	3.14	12.70	29.19	53.59			
300'	4.20	17.16	40.19				
200'	6.35	26.80	67.71				
100'	13.40						

**Derivation of Table**

Given: Radius and X Find: Offset Y

$$(1) R \sin \Delta = X \implies \sin \Delta = \frac{X}{R}$$

$$(2) R - R \cos \Delta = R(1 - \cos \Delta)$$

Given: Y and X Find: Radius

$$(1) \tan \frac{\Delta}{2} = \frac{Y}{X}$$

$$(2) R = \frac{X}{\sin \Delta}$$

**Note:**

For approximate results, the following simpler formula can be used.

(The error is 1% when  $X = 0.2R$ )

$$(Y = \frac{X^2}{2R})$$

**Table 2A.F.1 Distance from Beginning or End of Curve Along Tangents (continued)**

**Example:**

Given Radius = 900'.

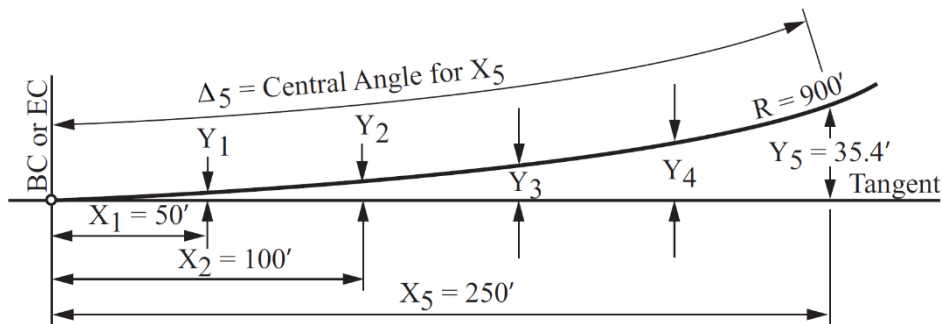
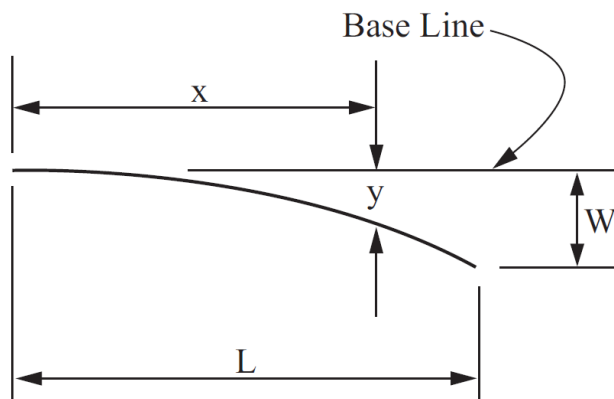

**Figure 2A.F.1 Example of Distances along Tangent from Curve**



# Bridge Design Details 2G October 2019

## Parabolic Curve Flares



$$y = \frac{Wx^2}{L^2}$$

x = distance along base line in feet

y = offset from baseline in feet

L = length of flare in feet

**W = maximum offset in feet\***

### Width to Length Ratio = 1.5

Flare Length	X=10	X=15	X=20	X=25
25	0.80	1.80	3.20	<b>5.00*</b>

Flare Length	X=10	X=20	X=30	X=40	X=50
50	0.40	1.60	3.60	6.40	<b>10.00*</b>

### Width to Length Ratio = 1.10

Flare Length	X=10	X=20	X=30	X=40	X=50
50	0.20	0.80	1.80	3.20	<b>15.00*</b>

Flare Length	X=10	X=20	X=30	X=40	X=50	X=60	X=70	X=80	X=90	X=100
100	0.10	0.40	0.90	1.60	2.50	3.60	4.90	6.40	8.10	<b>10.00*</b>

### Width to Length Ratio = 1.15

Flare Length	X=10	X=20	X=30	X=40	X=45
45'	0.15	0.59	1.33	2.37	<b>3.00*</b>

Flare Length	X=10	X=20	X=30	X=40	X=50	X=60	X=70	X=75
75'	0.09	0.36	0.80	1.42	2.22	3.20	4.36	<b>5.00*</b>

Flare Length	X=10	X=20	X=30	X=40	X=50	X=60	X=70	X=80	X=90
90'	0.07	0.30	0.67	1.19	1.85	2.67	3.63	4.74	<b>6.00*</b>

Flare Length	X=10	X=20	X=30	X=40	X=50	X=60	X=70	X=80	X=90	X=100	X=110	X=120
120'	0.06	0.22	0.50	0.89	1.39	2.00	2.72	3.56	4.50	5.56	6.72	<b>8.00*</b>

**Table 2A.G.1 Offset "y" in Feet for Given Distance "x"**



# Bridge Design Details 2.5 January 2023

## Horizontal Alignment

A horizontal alignment is provided in the Bridge Site Submittal from the District and is given as a stationed layout line for highways, off-ramps, walls, or other structures. All horizontal alignments are laid out by stations, which are given as 100-foot increments along the layout line. For smaller structures, the station line may be given as 20-foot increments along the layout line (e.g., +20, +40, +60, etc.). Whole stations shall not include “plus stations” (e.g., 10+00). For three-digit whole stations, it is acceptable to drop the first two digits and fully label every 500 feet (e.g., 100, 1, 2, 3, 4, 105, etc.).

## Stations

Locations along a station line are generally shown to the nearest hundredth of a foot and without the station abbreviation (Sta).

**Example:** 12+56.00 "A" LINE

## Bearings

Bearing direction for tangent lines, follows the direction of increasing stationing and north arrow.

## Offsets

Any location within the same plane of a given horizontal alignment can be found using a station-offset from a specific alignment. Offsets are distances, left or right, from any given station line to the location of a specific point.

**Example:**  $P_1$  is offset 2.00 feet left of station 12+10.00.

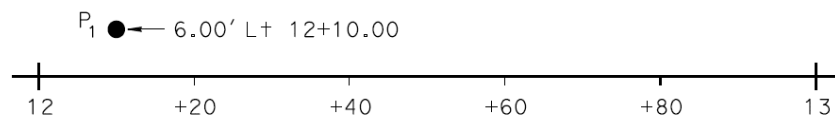
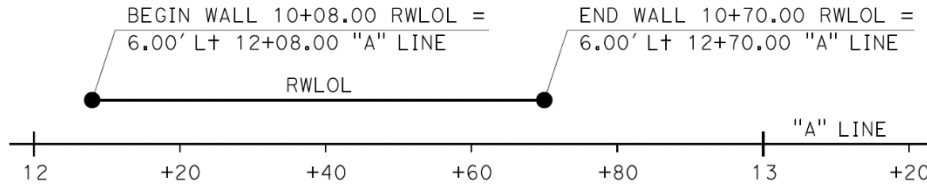

**Figure 2.5.1 Point Offset Location**



It is common practice to either begin retaining wall layout lines at 10+00.00 or to match the beginning station to the corresponding mainline alignment.

**Example:** Beginning of wall is 6.00 feet left of station; 12+08.00 "A" Line.



**Figure 2.5.2 Retaining Wall Offset Locations**





# Bridge Design Details 2H October 2019

## Develop Horizontal Alignment Stations

Examples:

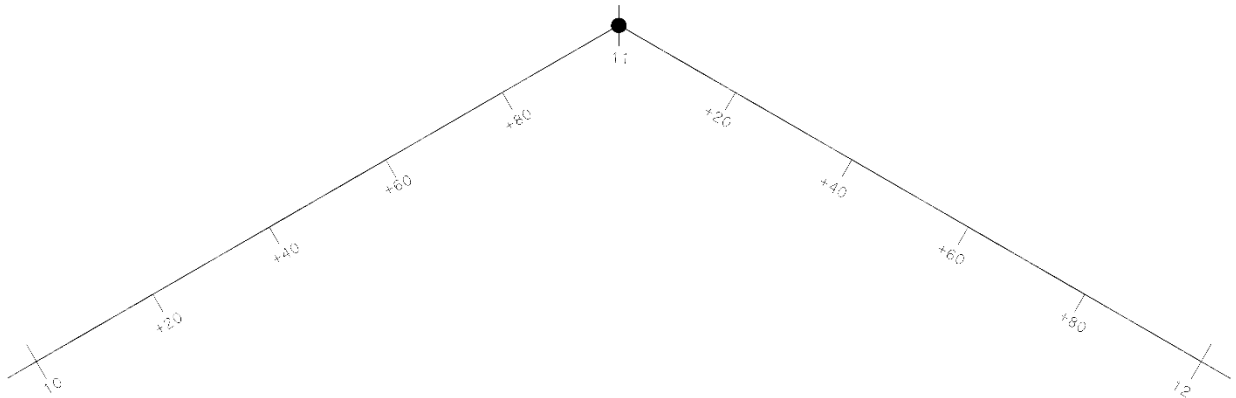

Figure 2A.H.1 Alignment Stationing without Horizontal Curve

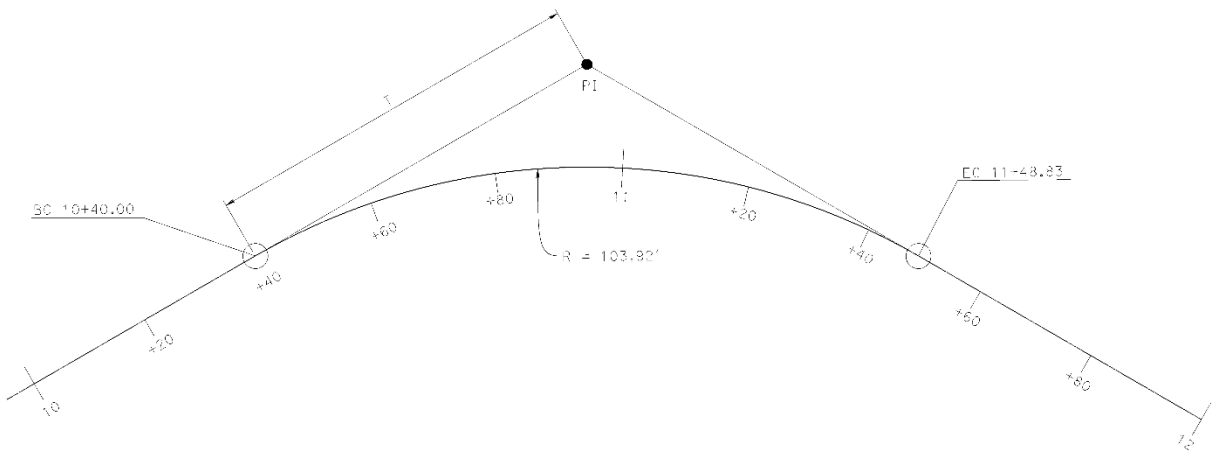

Figure 2A.H.2 Revised Alignment Stationing with Horizontal Curve



Figure 2A.I.1 Horizontal Alignment Examples

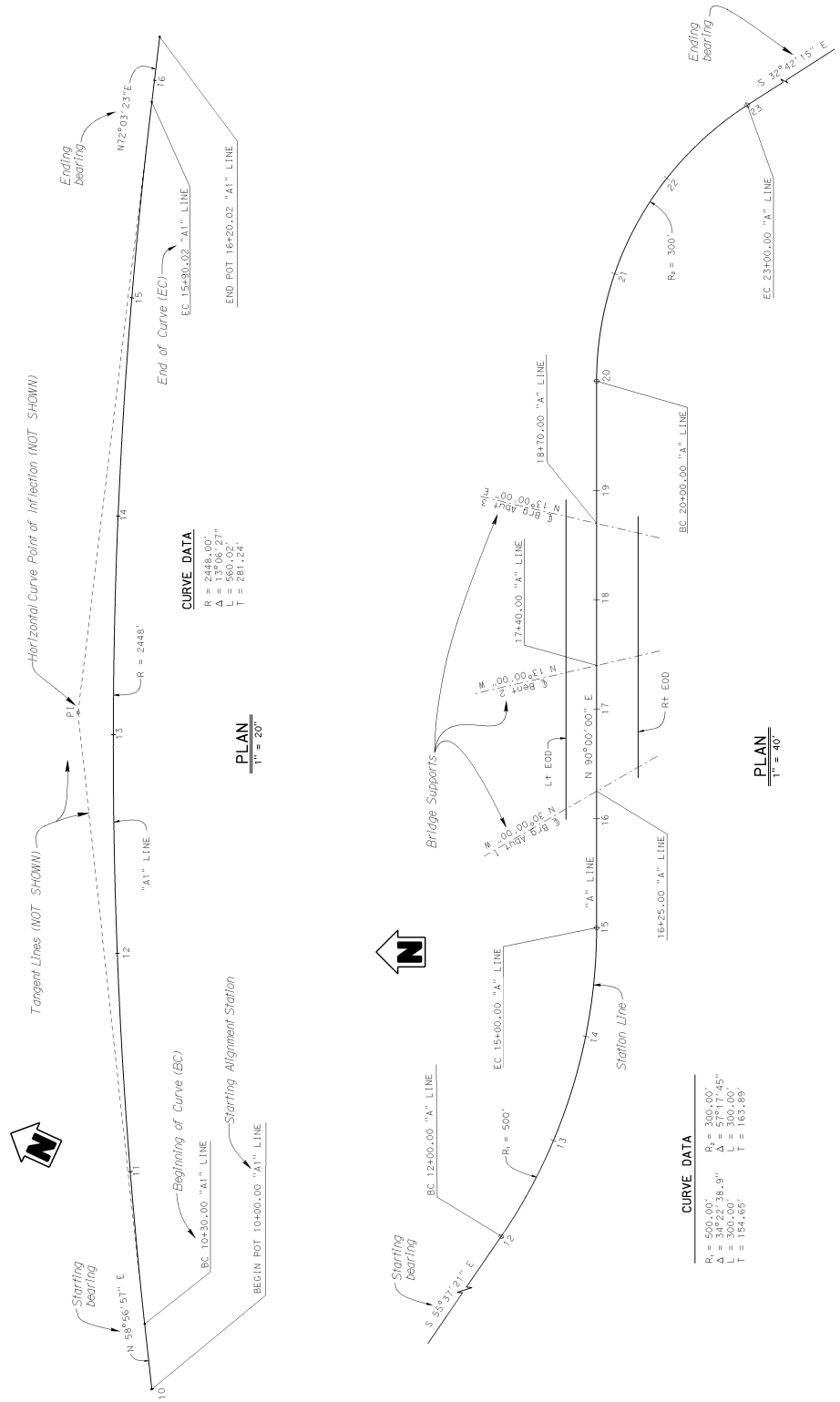



Figure 2A.J.1 Projecting Parallel Horizontal Alignment Example

