

20-7A

APPENDIX A: Reinforcement Details for Column to Slab Connections and for Hinges

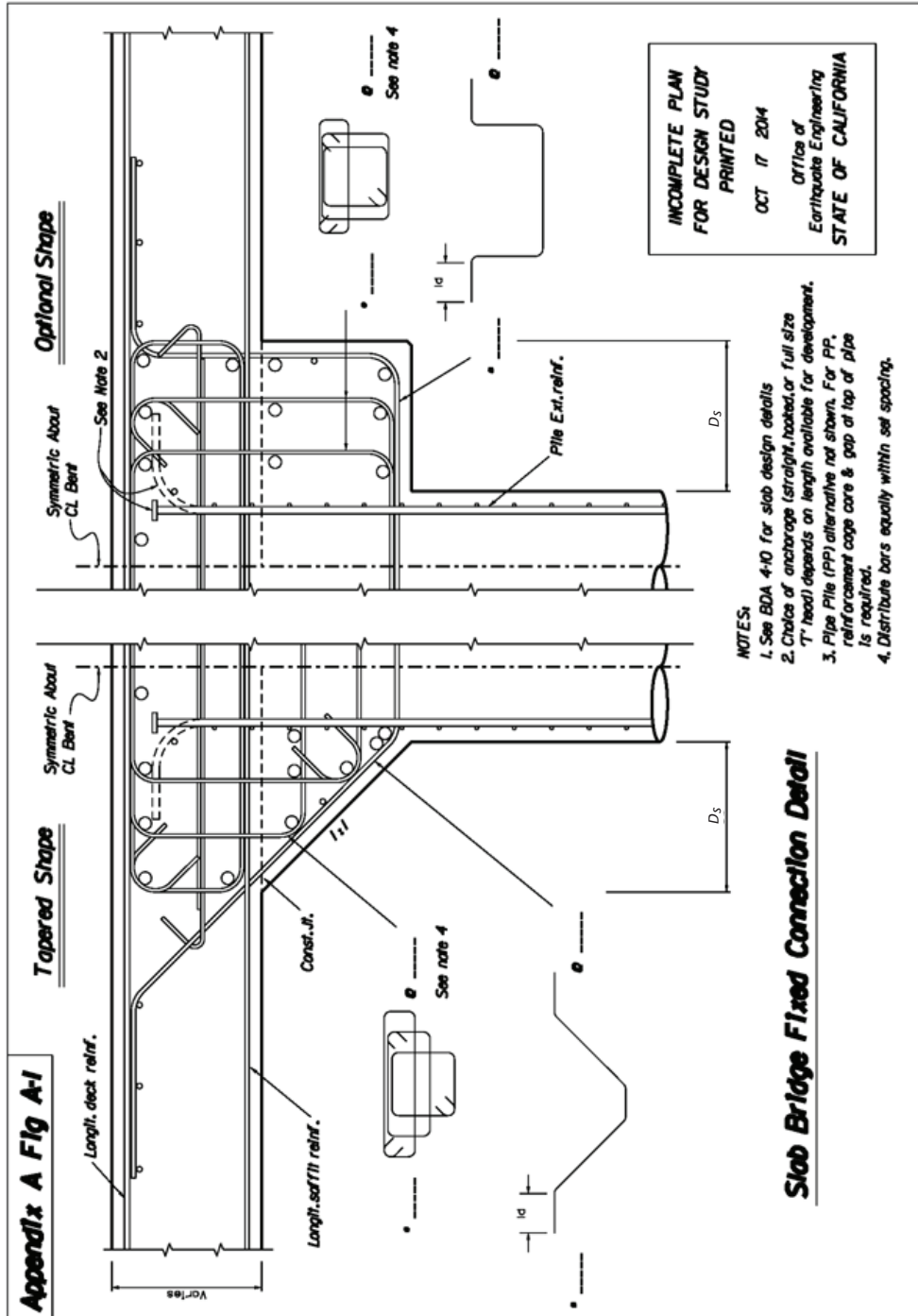

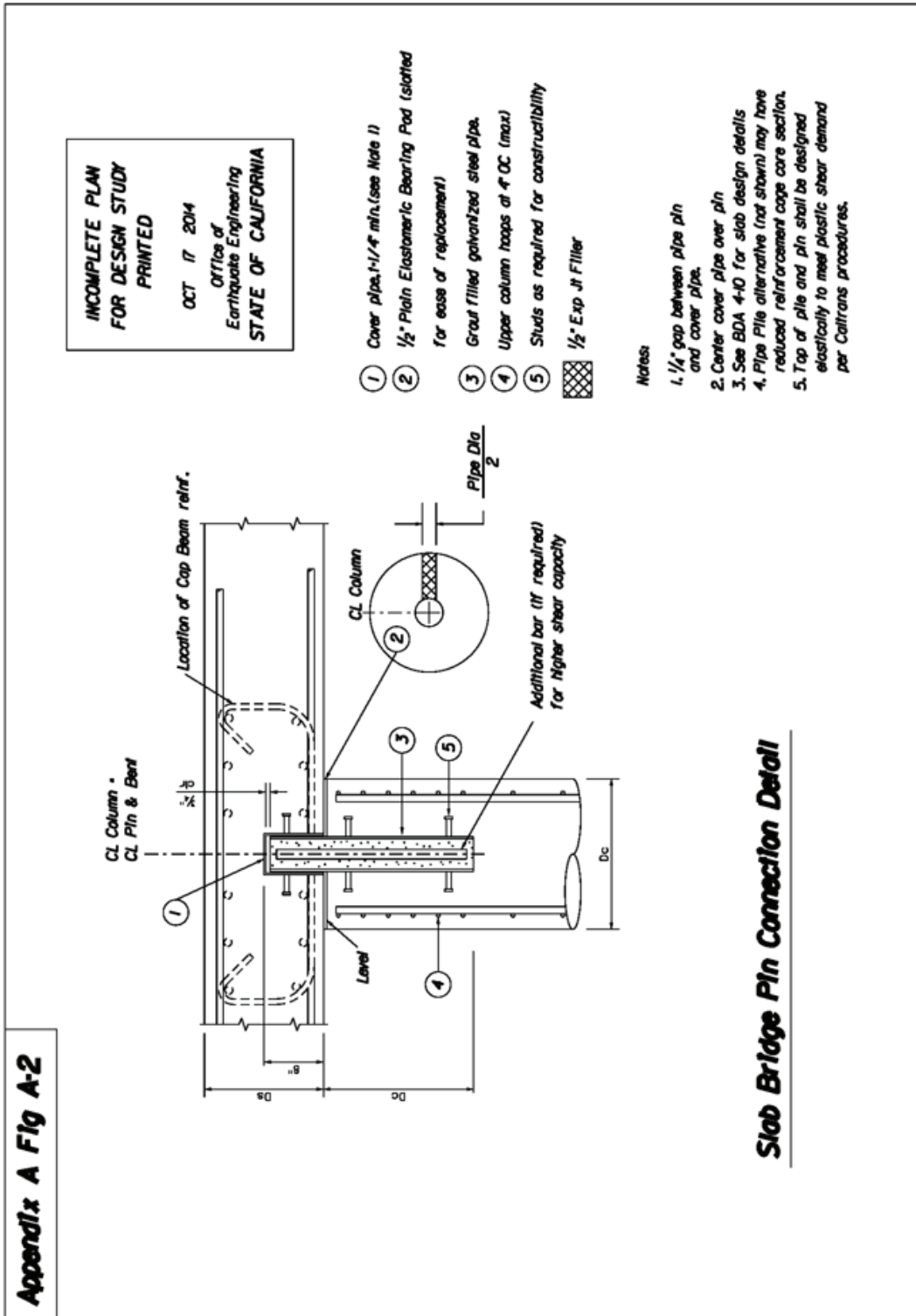

Note: The Bearing Pad in Figure A-2 has a slot to facilitate replacement while preventing movement.

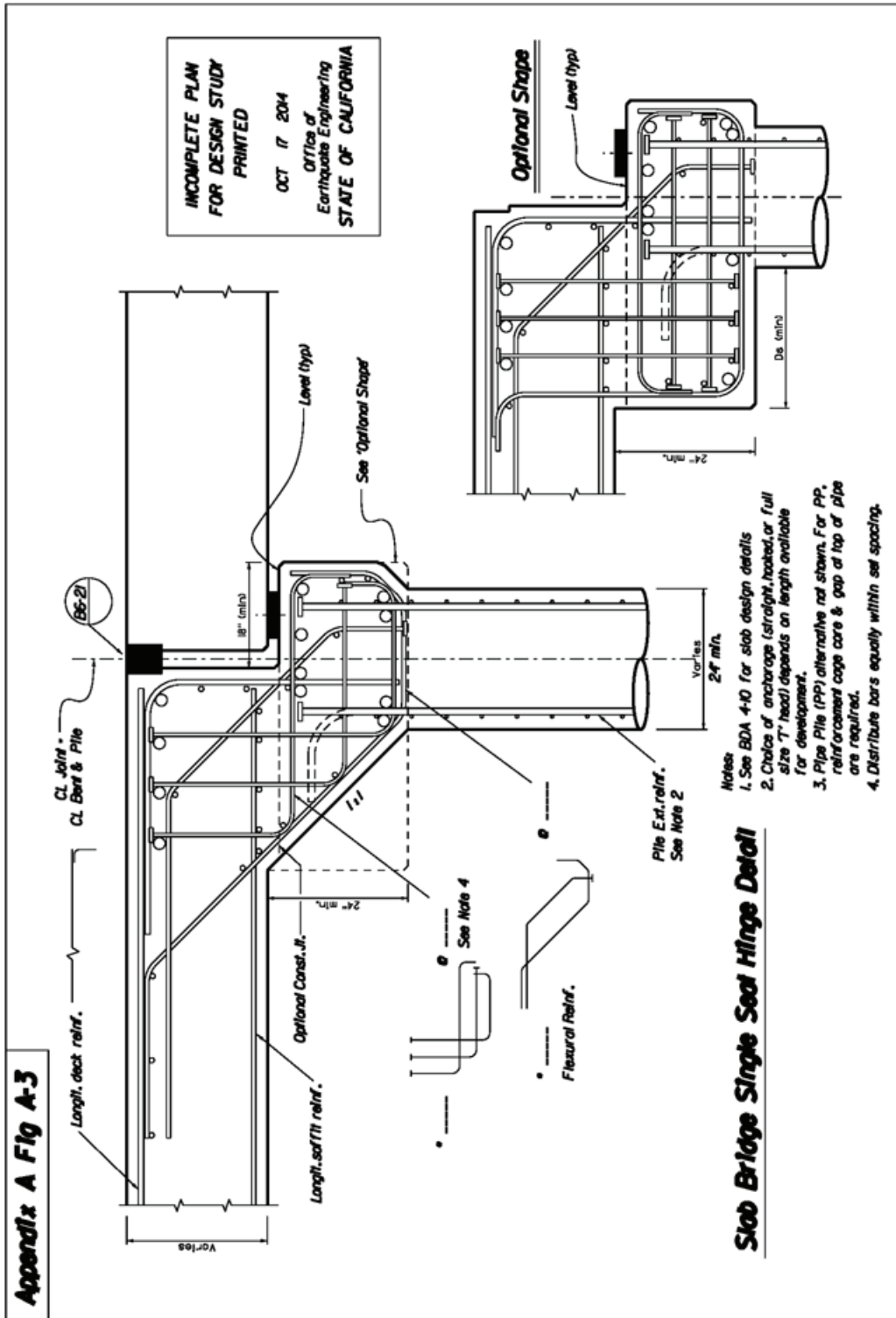

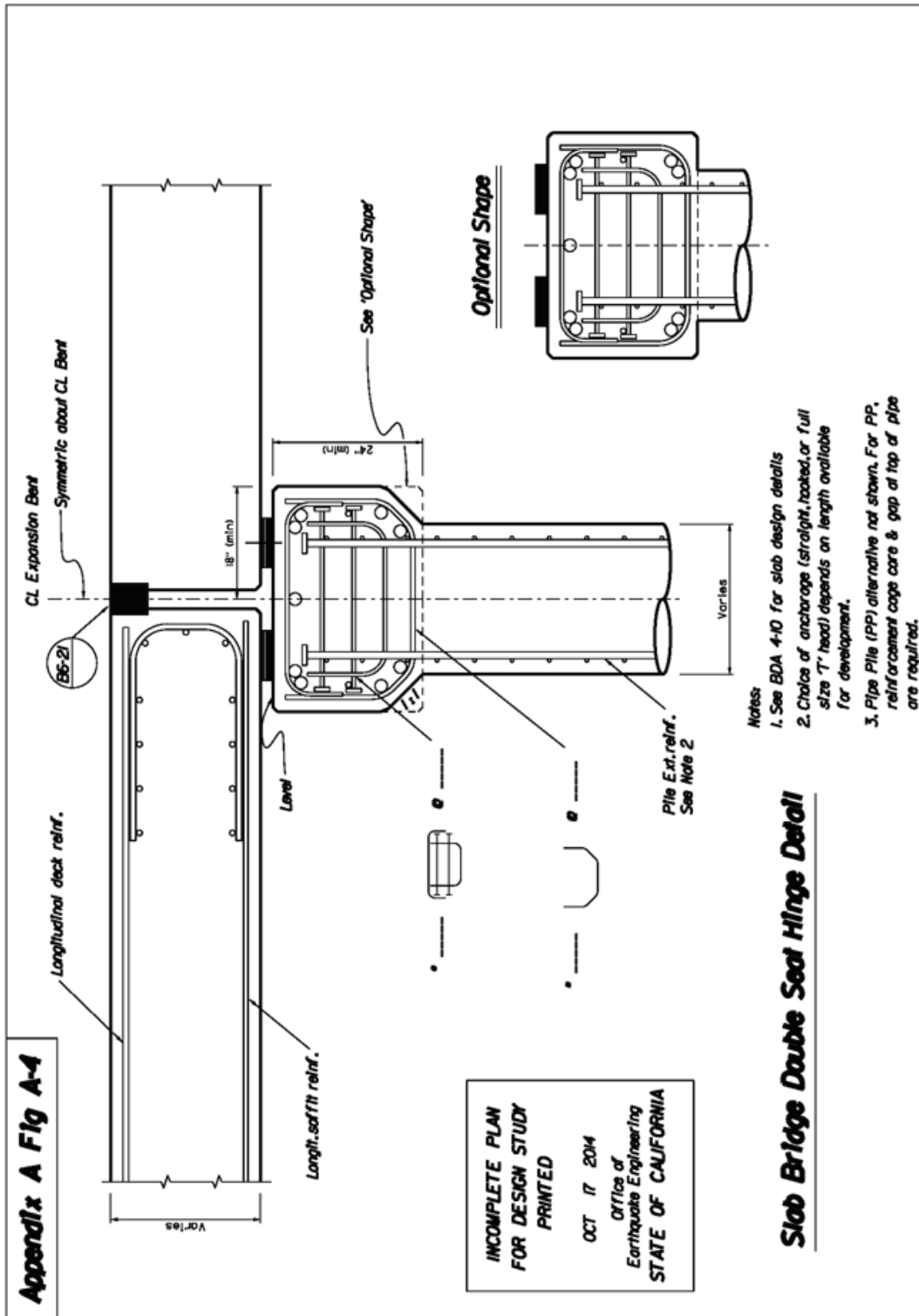

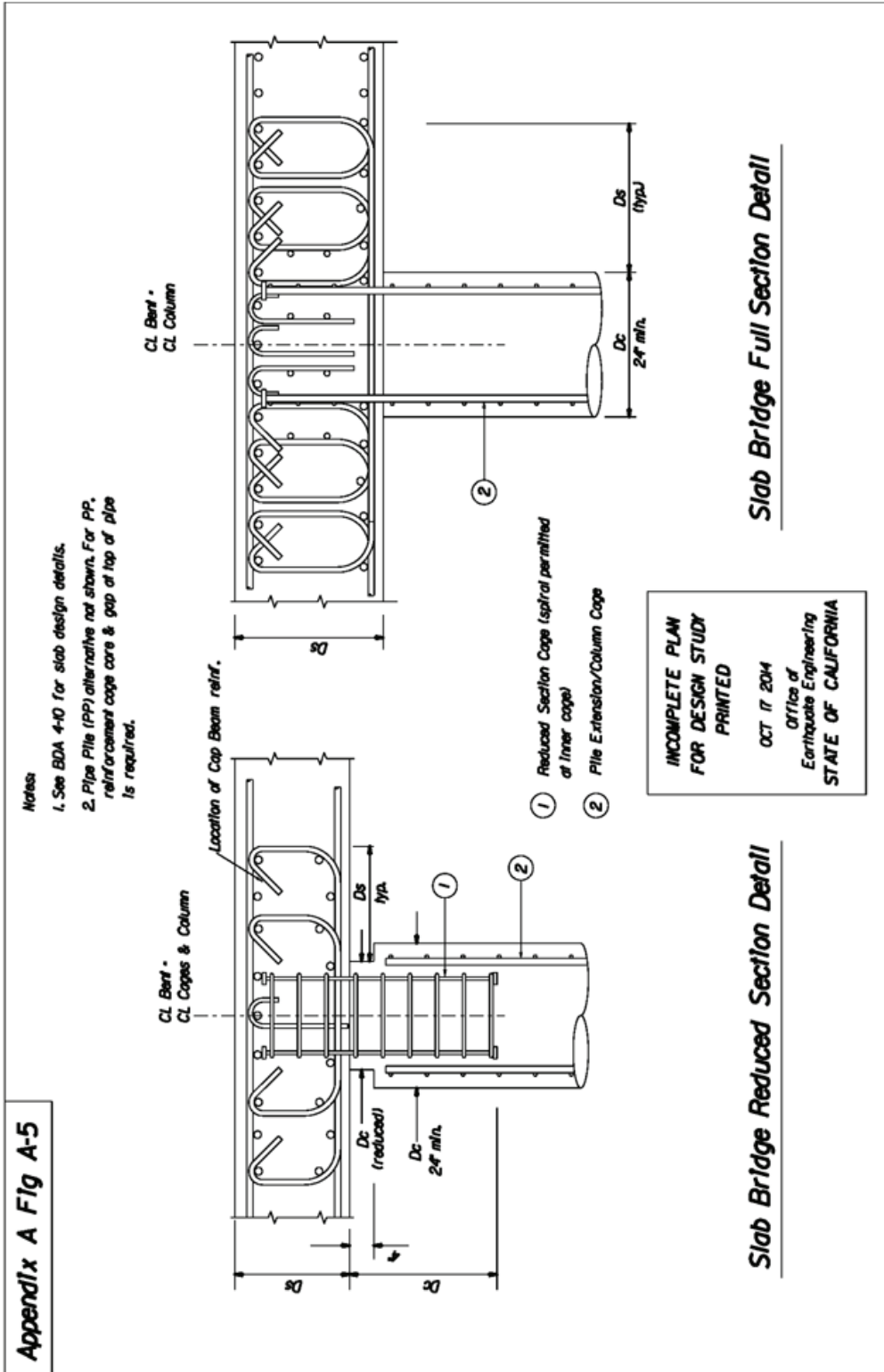

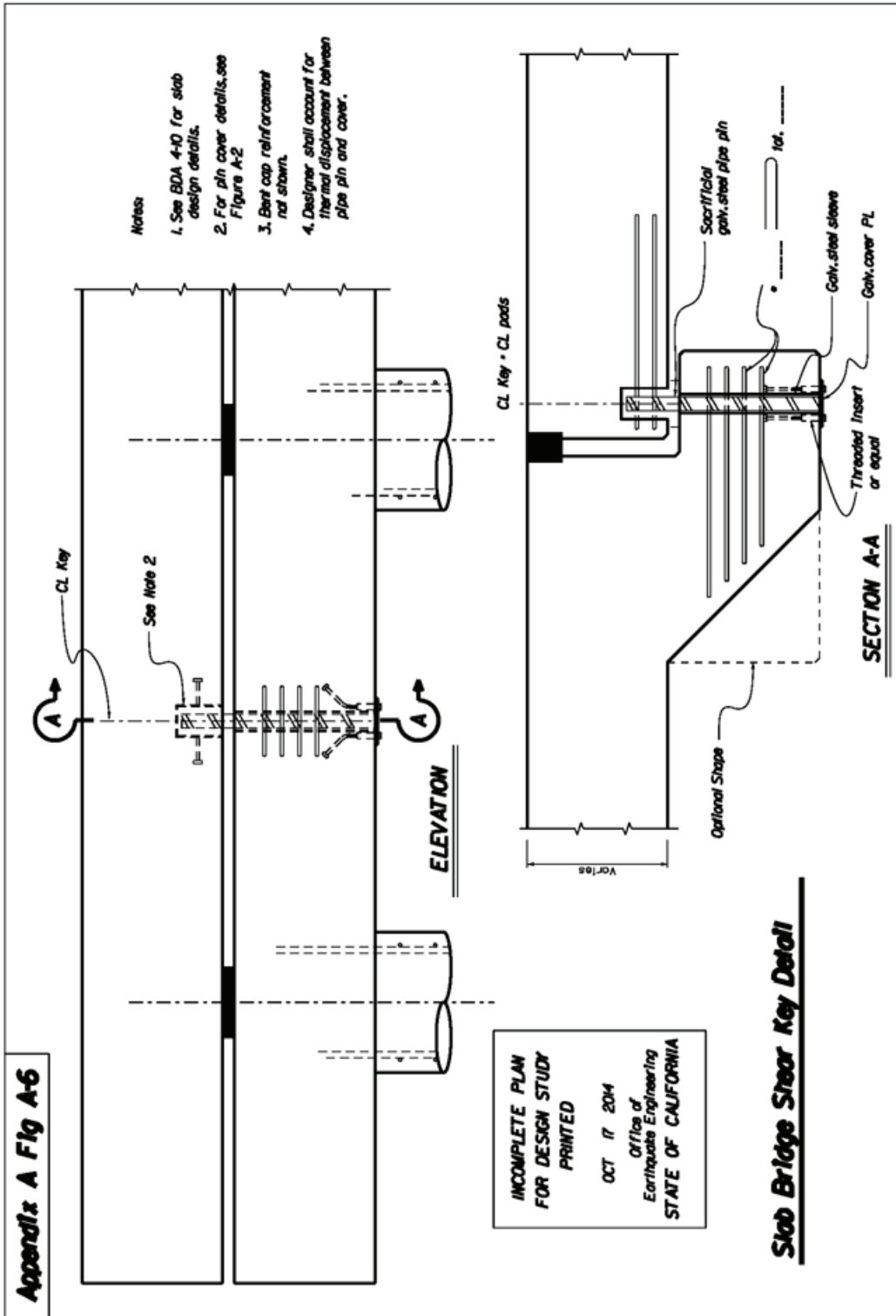

Note: Isolated shear keys in Figure A-6 are to prevent excessive movement during small earthquakes.

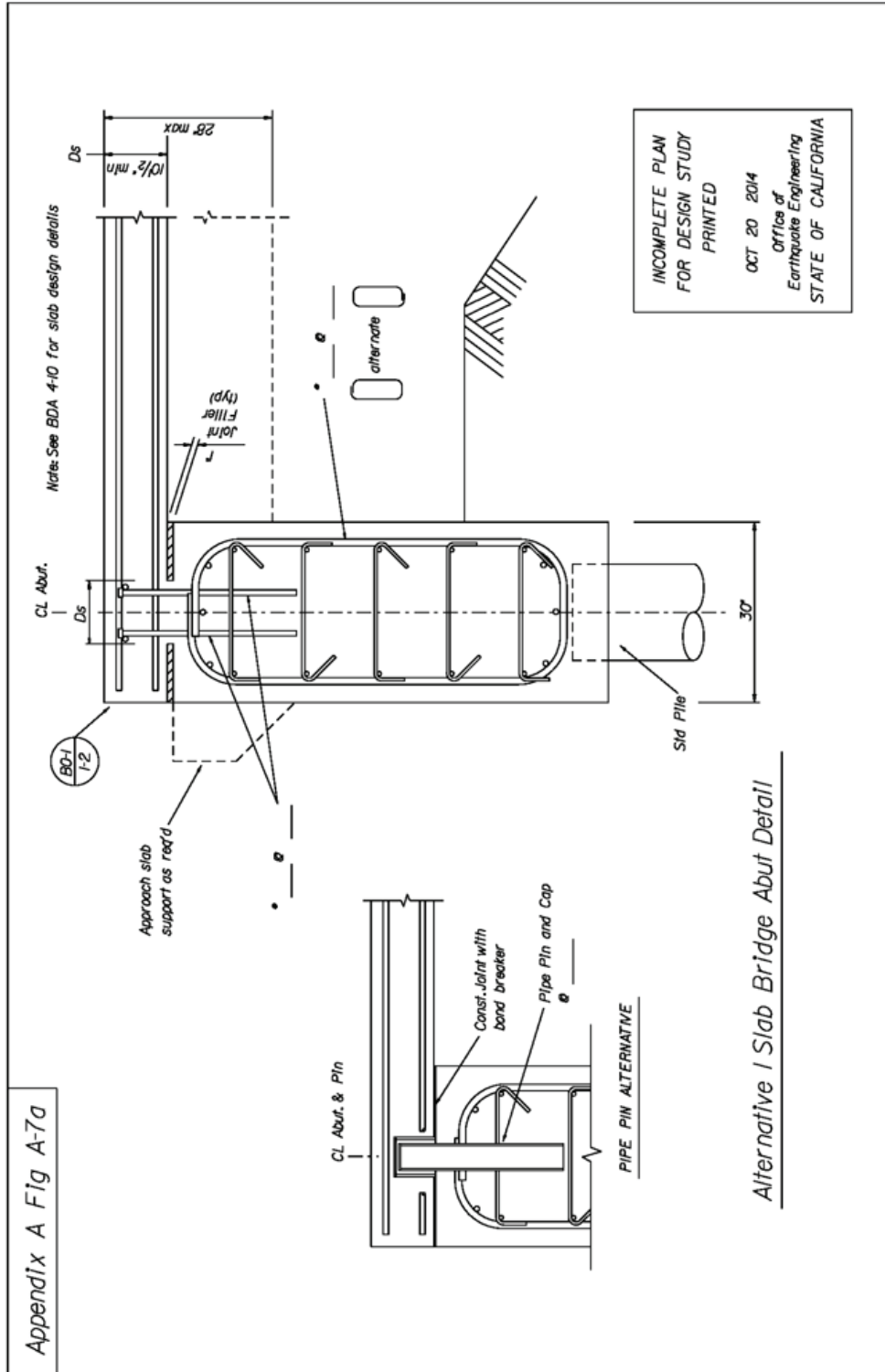

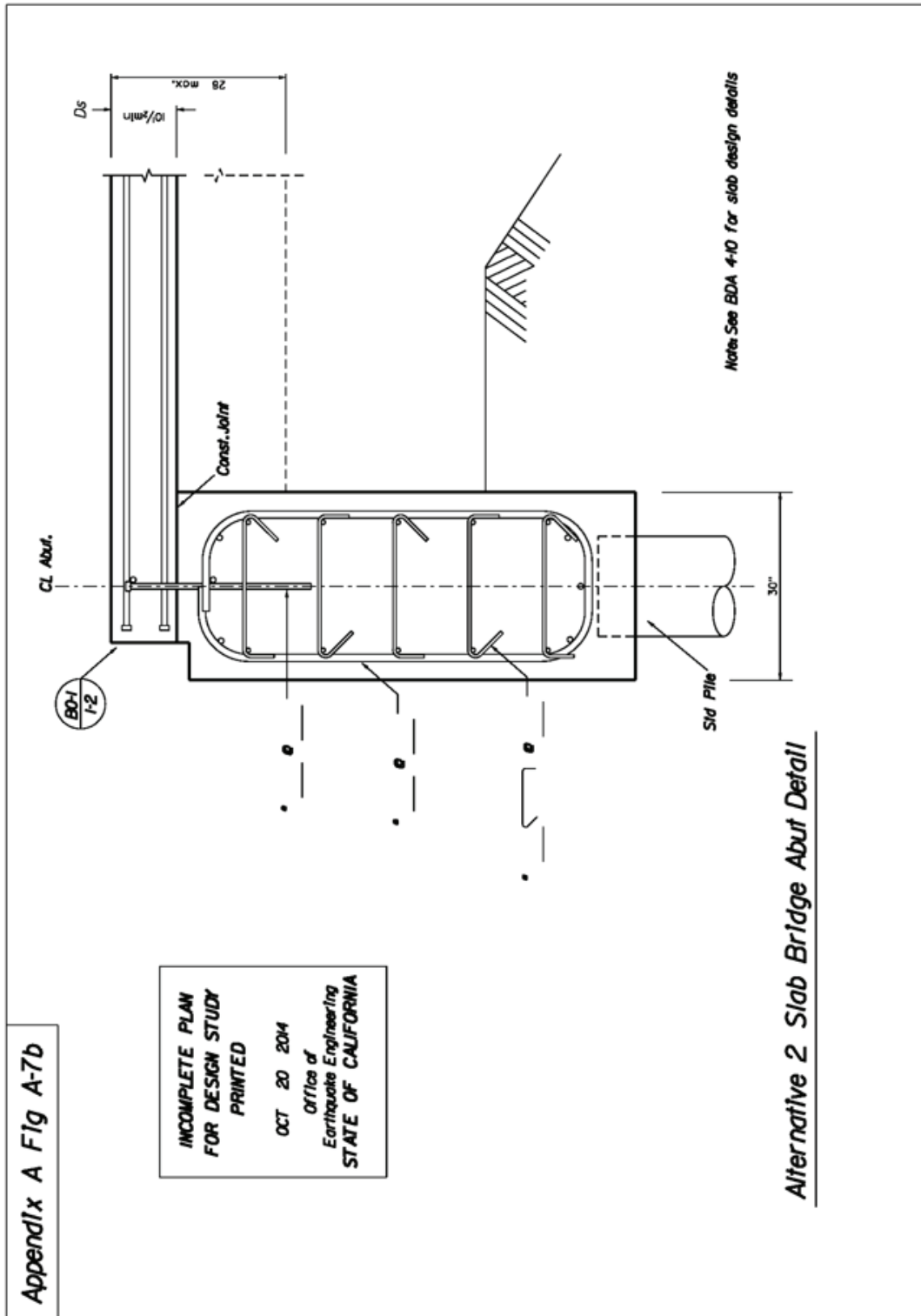

Appendix A Fig A-7b

INCOMPLETE PLAN  
FOR DESIGN STUDY  
PRINTED  
OCT 20 2014  
Office of  
Earthquake Engineering  
STATE OF CALIFORNIA

Alternative 2 Slab Bridge Abutment Detail



